



OPERATING INSTRUCTIONS ECON-M



Installation Guide

INDEX

- 1.0 Introduction
- 2.0 Salient features, Protection & Supervision
- 3.0 Display/ Front Panel
- 4.0 Switches Description
- 5.0 LED Annunciations Description
- 6.0 Lamp Test
- 7.0 Digital Input
- 8.0 Analog Input
- 9.0 Digital Output
- 10.0 Operating Mode
- 11.0 Setting Procedure
- 12.0 Parameter Mode
 - 12.1 System Parameter
 - 12.2 Generator Parameter
 - 12.3 Protection Parameter
 - 12.4 RS 485 Parameters
 - 12.5 Annunciation Parameter
 - 12.6 Reset Service Alarm
 - 12.7 Adjust Clock
 - 12.8 Reset Password
- 13.0 Analog Channel Data
 - 13.1 High Water Temperature Sensors Data
 - 13.2 Low Fuel Sensors Data
 - 13.3 Low Lube Oil Pressure Sensors Data(Resistive Type)
 - 13.4 Low Lube Oil Pressure Sensors Data (4-20mA Type)
- 14.0 Relay Expander Module
- 15.0 Model Selection Chart
- 16.0 Load Management
- 17.0 Event Recording
- 18.0 Faults
 - 18.1 Internal Faults
 - 18.2 External Faults
 - 18.3 Fault Reset
- 19.0 Communication
- 20.0 Specifications
- 21.0 Terminal description
- 22.0 Dimension

• 1.0 Introduction

Microprocessor based controller for DG Set which can be configured as manual controller.

- **ECON-M:** This is a pure manual controller for manual operation only. All these models can be ordered with optional features such as RS485 communication, 3 Extra digital inputs of Canopy fan current protection. This manual has to be read along with the controller selected and all the features may not be available in all the models.
- Display: 128*64 pixel graphical backlit LCD for ease of readout and symbolic representation.
- Fan Current monitoring for canopy fan (Optional)
- Menu driven MMI for easy in field configuration without PC or any customized equipment.
- Load Management . Load Dependent start/stop of 2nd DG in case of two DG application.
- Periodic Automatic Start of engine if not used for a predefined time to charge the battery as well as maintenance.
- ECON reminds user for timely service by indicating service due alarm.
- True RMS measurement of all measured parameters with 1% accuracy of measured value.
- Plug in connectors for error free replacement.
- Automatic real time based DG Start and Stop.
- Dimensions 167 x 129 x 41.8 mm.

• 2.0 Salient Features, Protection and Supervision

- **Generator Measurements**
 - 1 Phase / 3 Phase Voltage
 - 1 Phase / 3 Phase Current
 - Frequency
 - Canopy Fan Current (optional)
 - PF, KW, KVA, KWH .
 - Battery Voltage
 - Water Temperature
 - Oil Pressure
 - Fuel Level
 - RPM
 - Run Hour
 - Service Due Hour

• Protection / Supervision DG

- Under/Over Voltage
- Current Unbalance
- LLOP
- Low fuel
- Emergency off
- RWL
- Under/Over Frequency
- Overload
- HWT
- Charging Alternator/V-belt
- Service Due

• **Digital Input** : 7 digital (3 fixed, 4 programmable)

• **Output**: 7 digital

• **AMF Operation**: 7 outputs (three fixed and three programmable) and one for charging Alternator

• **Fault Data Recording**: Last 64 fault with date and time stamping

• **Event Recording**: Last 64 event with date and time stamping

• **Start Stop Recording**: Last 100 records with date and time stamping

• **Password Protection**: Three digit password protection for system settings.

• Real Time Clock (RTC)

• **Communication**: RS232, USB, Fully Isolated RS485(Optional)

• Provision for switching ON or OFF the measurement for individual sensors.

• Option of warning or tripping when open sensor is detected

• Programmable crank cut off method based on either.

- Voltage + Frequency
- Voltage + Frequency + LLOP Switch
- Voltage + Frequency + Sensor
- Voltage + Frequency + Sensor + Switch



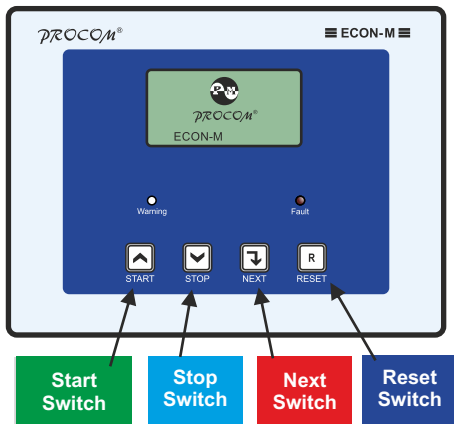

• 3.0 Display / Front Panel



- 128x64 pixels Graphical LCD Display for ease of readout. Parameters are displayed in English along with symbolic representation. Normally the display auto scrolls and displays a parameter for 10 seconds, but any time the Next key () can be pressed to select the next parameter window.

• 4.0 Switches Description

ECON-M has 4 switches provided on its front panel. The table below describes the operation of these.

Switch Symbol	Switch Function	Description
	Next	Normal operation mode: In this mode, it is used to change the parameters being displayed on LCD. Programming Mode: Next key is used to select the next parameter to be programmed.
	Increment /Start	This key has dual function Programming Mode: It is used to increment the value of the parameters under programming. Manual mode: it is used to issue the crank/start command to DG
	Decrement /Stop	This key has dual function Programming mode: It is used to decrement the value of the parameter under programming. Manual mode: It is used to issue the stop command to DG
	Reset	Reset key resets the Hooter and Fault signals. The first press shall reset the hooter and next shall reset the faults. A long press of 1 Sec shall reset both.
	Programming Mode Entry	If both the keys are pressed simultaneously the unit will enter in Programming Mode.

- **5.0 LED Annunciations Description:** ECON has two annunciations on its front panel. These either announce the faults or indicate status of the system.

Nomenclature	Description
Warning	This LED blinks in case of a warning.
Fault	This LED blinks in case of a fault.

- **6.0 Lamp Test:**

If the ECON is switched on while the reset switch is pressed, all the LEDs start blinking till reset switch is kept pressed.. This state shall persist till the switch is kept pressed and on release of the switch ECON shall start functioning normally

- **7.0 Digital Input:** ECON has 7 digital input as below

- **Fixed Inputs :** ECON has 3 Fixed Input.

- Remote Start,
- Remote Stop
- Emergency

- **Programmable 4 inputs each can be programmed as one of the following inputs.**

- RWL Switch
- Fuel Switch
- Oil Level Switch
- Oil Temperature Switch
- None
- LLOP Switch
- HWT Switch
- Canopy Temperature Switch
- Earth Fault
- Gas Leak

- **8.0 Analog Input:** ECON has 4 Analog Input

- Low Lube Oil Pressure Sensor
- High Water Temperature Sensor
- Low Fuel Level Sensor
- OIL Temperature Sensor (ECON -M-421/422 only)

• **9.0 Digital Output:** ECON has 7 digital outputs :

• **Programmable output**

Three digital outputs can independently be configured for the any functions from the list below.

- Unit Healthy
- Fuel Pump
- Pull Solenoid
- Load Warning
- Heater/Choke
- None

• **Fixed output:** The remaining 4 digital outputs are fixed:

- Charging Alt(Battery Voltage)
- Solenoid
- Crank
- Hooter

• **10.0 Operating Mode**

***Manual Based Operation :**



This mode is a pure manual operation mode. The engine has to be manually started and stopped. The responsibility of disengaging the load from generator and allowing the engine to cool before stopping has to be performed by the operator. The engine and Alternators are protected while the engine is running.



***RTC Based operation :**

In ECON-M, the RTC based start stop can be activated. If activated the engine can be made to automatically start at a given time of the day and stop at a predefined time.

• **11.0 Setting Procedure: How to Enter in Parameter Mode**

Press Next & Reset switches simultaneously. The LCD shall display, “**System Parameter**”

To enter System Parameter setting mode,  press **Next Switch**, the LCD shall display, “**Enter Password**” and default password is 123 then press **Next Switch**. For any change in value, press  **Start switch** and  **Stop switch**. For next parameter, press Next Switch.

To go to next menu press Start Switch the LCD shall display “**Generator Parameter**” To enter Generator Parameter setting mode press **Next Switch**. For any change in value, press  **Start switch** and  **Stop switch**. For next parameter, press **Next Switch**.

To go to next menu press Start Switch the LCD shall display “**Protection Parameter**” To enter Protection Parameter setting mode press **Next Switch**. For any change in value, press  **Start switch** and  **Stop switch**. For next parameter, press **Next Switch**.

To go to next menu press Start Switch the LCD shall display “ **Comm RS485** ” To enter Comm RS-485 Parameter setting mode press **Next** Switch. For any change in value, press **Start** switch and **Stop** switch For next parameter, press **Next** Switch.

To go to next menu press Start Switch the LCD shall display “**Edit Annunciation**” To enter Edit Annunciation setting mode press **Next** Switch. For any change in value, press **Start** switch and **Stop** switch. For next parameter, press **Next** Switch.

To go to next menu press Start Switch the LCD shall display “**Display History**” To View Display History mode press Next Switch.

To go to next menu press Start Switch the LCD shall display “**Display Event**” To View Display Event mode press Next Switch.

To go to next menu press Start Switch the LCD shall display “**Display Start/Stop**” To View Display Start/Stop mode press Next Switch.

To go to next menu press Start Switch the LCD shall display “**Reset Service Alarm**” To enter Reset Service Alarm mode press Next Switch. The LCD shall display

**“Press START to Reset
Press STOP to ESC”**

The unit shall ask for confirmation to reset the service hours pressing desired Switch.

To go to next menu press Start Key the LCD shall display “**Adjust Clock**” To enter Adjust Clock setting mode press Next Key. For setting up of the time, press Start switch and Stop switch.

Press Next Key the LCD shall display DD/MM/YYYY. For setting up of the date, press Start switch and Stop switch

To go to next menu press Start Key the LCD shall display “**Reset Password**” To enter Reset Password setting mode



Press “**Enter Password**” then Press “**Change Password**” the LCD shall display “

**Press START to Change
Press STOP to ESC”**

• **12.0 Parameter Mode:**

The following tables give the detailed descriptions. Please note that 20sec of inactivity will take the unit back in normal mode and all the changes done shall be cancelled.

• **12.1 System Parameter**

Parameter Name on LCD & Icon	Explanation of Parameter	Factory Setting	Setting Range
Enter Password	Systems setting are password protected. Password is a three digit number	123	0-999
System Config A/M 	ECON provides complete flexibility in system designing; it is possible to select manual operation for DG phases.	MANUAL 3P	MANUAL1P MANUAL 3P
Solenoid Type 	Pull To Start In this mode fuel solenoid contact changes from Open to Close at the time of cranking and remains close till the genset is running. For stopping the generator this contact opens. Pull To Stop In this mode fuel solenoid contact remains open at the time of cranking and till the genset is running. For stopping the generator this contact closes for a user programmed time.	Pull to Stop	Pull to Stop Pull to Start
LLOP Sensor Type 	Select the installed sensor for LLOP	Type A	User Defined Type A M&M MNEPL VE TMTL HUAFANG TATA GC(VDO) GC(MURPHY) 4-20mA Disabled



LLOP Sensor R1	R1 to R10 = Resistance Value V1 to V10 = Corresponding pressure value. These table are used when sensor type is selected as user defined.	10	0-999
LLOP Sensor V1		0.0	0.0-10.0
LLOP Sensor R2		29	0-999
LLOP Sensor V2		1.0	0.0-10.0
LLOP Sensor R3		38	0-999
LLOP Sensor V3		1.5	0.0-10.0
LLOP Sensor R4		48	0-999
LLOP Sensor V4		2.0	0.0-10.0
LLOP Sensor R5		57	0-999
LLOP Sensor V5		2.5	0.0-10.0
LLOP Sensor R6		67	0-999
LLOP Sensor V6		3.0	0.0-10.0
LLOP Sensor R7		86	0-999
LLOP Sensor V7		4.0	0.0-10.0
LLOP Sensor R8		105	0-999
LLOP Sensor V8		5.0	0.0-10.0
LLOP Sensor R9	124	0-999	
LLOP Sensor V9	6.0	0.0-10.0	
LLOP Sensor R10	143	0-999	
LLOP Sensor V10	7.0	0.0-10.0	







Fuel Sensor 	Select the installed sensor for Fuel	Type A	User Defined Type A, Sam-0, Sam-1, Electronics, Linear, 0-5V(0-100%), Disabled*
Fuel Sensor R1	R1 to R10 = Resistance Value V1 to V10 = Corresponding fuel level in %. These table are used when sensor type is selected as user defined.	10	0-999
Fuel Sensor V1		0	0-100
Fuel Sensor R2		29	0-999
Fuel Sensor V2		10	0-100
Fuel Sensor R3		48	0-999
Fuel Sensor V3		20	0-100
Fuel Sensor R4		67	0-999
Fuel Sensor V4		30	0-100
Fuel Sensor R5		86	0-999
Fuel Sensor V5		40	0-100
Fuel Sensor R6		105	0-999
Fuel Sensor V6		50	0-100
Fuel Sensor R7		124	0-999
Fuel Sensor V7		60	0-100
Fuel Sensor R8		143	0-999
Fuel Sensor V8		70	0-100
Fuel Sensor R9		181	0-999







Fuel Sensor V9		90	0-100
Fuel Sensor R10		200	0-999
Fuel Sensor V10		100	0-100
HWT Sensor 	Select the installed sensor for HWT	Type A	User Defined Type A, Type B,M&M, MNEPL,VE, TMTL AIR 1C, TMTL AIR 3C, TMTL WATER HUAFANG, TATA, GC(VDO), GC(MURPHY), Disabled *
HWT Sensor R1	R1 to R10 = Resistance Value V1 to V10 = Corresponding temperature in °C. These table are used when sensor type is selected as user defined.	540	0-9999
HWT Sensor V1		40	0-300
HWT Sensor R2		458	0-9999
HWT Sensor V2		45	0-300
HWT Sensor R3		222	0-9999
HWT Sensor V3		65	0-300
HWT Sensor R4		120	0-9999
HWT Sensor V4		85	0-300
HWT Sensor R5		93	0-9999
HWT Sensor V5		90	0-300
HWT Sensor R6		80	0-9999
HWT Sensor V6		95	0-300

HWT Sensor R7		70	0-9999
HWT Sensor V7		100	0-300
HWT Sensor R8		60	0-9999
HWT Sensor V8		105	0-300
HWT Sensor R9		53	0-9999
HWT Sensor V9		110	0-300
HWT Sensor R10		46	0-9999
HWT Sensor V10		115	0-300
Oil Temp. Sensor # 	Select the installed sensor for Oil Temp.	Type A	User Defined Type A, Type B,M&M, MNEPL,VE, TMTL AIR 1C, TMTL AIR 3C, TMTL WATER HUAFANG, TATA, GC(VDO), GC(MURPHY), Disabled *
Oil Temp. Sensor R1	R1 to R10 = Resistance Value V1 to V10 = Corresponding temperature in °C. These table are used when sensor type is selected as user defined.	540	0-9999
Oil Temp. Sensor V1		40	0-300





Oil Temp. Sensor R2	458	0-9999
Oil Temp. Sensor V2	45	0-300
Oil Temp. Sensor R3	222	0-9999
Oil Temp. Sensor V3	65	0-300
Oil Temp. Sensor R4	120	0-9999
Oil Temp. Sensor V4	85	0-300
Oil Temp. Sensor R5	93	0-9999
Oil Temp. Sensor V5	90	0-300
Oil Temp. Sensor R6	80	0-9999
Oil Temp. Sensor V6	95	0-300
Oil Temp. Sensor R7	70	0-9999
Oil Temp. Sensor V7	100	0-300
Oil Temp. Sensor R8	60	0-9999
Oil Temp. Sensor V8	105	0-300
Oil Temp. Sensor R9	53	0-9999
Oil Temp. Sensor V9	110	0-300
Oil Temp. Sensor R10	46	0-9999
Oil Temp. Sensor V10	115	0-300









Sensor Open 	User can select the action to be taken in case of sensor open, it can be configured as a fault, or as warning or no action to be taken i.e. disable.	Disabled	Disabled * Fault Warning
CT Ratio 	Current Transformer ratio	1	1-9999
Gen. RPM 	Engine RPM Type	1500RPM	1500RPM 3000RPM

<p>Contact ON Pin 32,31,30</p> 	<p>These are three programmable output which can be configured for any one function from the list</p>	None	<p>None Unit Healthy Load Warning Fuel Pump Heater /Choke Pull Solenoid</p>
<p>Over Load KW</p> 	<p>The Power(KW) above which the over load fault monitoring will start. The timer for it is as described in 13. This fault is only enabled while the generator is running. On expiry of the timer the generator is stopped</p>	40	1-9999
<p>Over Current</p> 	<p>The current above which the over current fault monitoring will start. The timer for it is as described in 13. This fault is only enabled while the generator is running. On expiry of the timer the generator is stopped</p>	50	1-9999
<p>Over Load Delay</p> 	<p>This is the timer for the over load condition either due to over KW or over current. On expiry of this timer the engine shall be stopped</p>	5 Sec	1-999 Sec
<p>Digital Input 1</p> 	<p>This can be configured for one out the listed below Parameters. RWL Oil Level Oil Temperature Canopy Temperature Earth Fault</p>	RWL	<p>RWL Oil Level Oil Temp. Canopy Temp. Earth Fault Gas Leak</p>
<p>Digital Input 2</p> 	<p>This can be configured for one out the listed below Parameters. LLOP Oil Level Oil Temperature Canopy Temperature Earth Fault</p>	LLOP	<p>LLOP Oil Level Oil Temp. Canopy Temp. Earth Fault Gas Leak</p>
<p>Digital Input 3</p> 	<p>This can be configured for one out the listed below Parameters. FUEL Oil Level, Oil Temperature Canopy Temperature Earth Fault</p>	FUEL	<p>FUEL Oil Level Oil Temp. Canopy Temp. Earth Fault Gas Leak</p>

Digital Input 4 	This can be configured for one out the listed below Parameters. HWT Oil Level Oil Temperature Canopy Temperature	HWT	HWT Oil Level Oil Temp. Canopy Temp. Earth Fault Gas Leak
Digital Input 5# 	This can be configured for one out the listed below Parameters. Canopy Temperature Oil Level Oil Temperature	Canopy Temp.	Canopy Temp. Oil Level Oil Temp.
Digital Input 6# 	This can be configured for one out the listed below Parameters. Oil Level Oil Temperature Canopy Temperature	Oil Level	Oil Level Oil Temp. Canopy Temp.
Digital Input 7# 	This can be configured for one out the listed below Parameters. Earth Fault Oil Temperature Oil Level	Earth Fault	Earth Fault Oil Temp. Oil Level
Digital Input 1-7 Polarity	The polarity of digital input can be changed either normally open or normally close.	Normally Open	Normally Open Normally Close
Fan High Current 	Maximum limit for fan current	2.0	0-3.5
Fan Low Current 	Minimum limit for fan current	0.2	0-3.5
Fan Current Delay 	This is the timer for fan current trip.	5	1-100







• 12.2 Generator Parameter









Generator O/V 	Max. Permissible Generator voltage, above this the Generator voltage is treated unhealthy & the Generator is stopped on voltage fault.	270V	50-300V
Generator U/V 	Min. permissible Generator voltage, below this the Generator voltage is treated unhealthy & the Generator is stopped on voltage fault.	180V	50-300V
Gen Voltage Delay  VOLT	Duration for which generator Over/Under voltage condition can be tolerated before stopping the Generator.	10 Sec	1-999 Sec
Generator O/F Hz↑	Max. Permissible Generator frequency, above this the Generator frequency is treated unhealthy & the Generator is stopped on frequency fault.	65Hz	25-70Hz Disable*
Generator U/F Hz↓	Min. permissible Generator frequency, below this the Generator frequency is treated unhealthy & the Generator is stopped frequency fault.	45Hz	Disable* 25-70Hz
Gen Freq Delay Hz⊕	Duration for which Generator Over /Under frequency condition can be tolerated before stopping the Generator. This setting is not available if (4)&(5) are disabled	5 Sec	1-999 Sec.
Current Unbalance IN 	The maximum permissible current unbalance in %. The unbalance starts only after the system is loaded to 25% of its capacity	Disable	5-100% Disable
Current Unbalance Delay 	Duration for which the current unbalance can be tolerated before triggering the fault	10 Sec	1-999Sec
Pickup Voltage uUU	This parameter specifies the generator voltage at which it is presumed to have started and crank has to be terminated	100V	80-150V





Service Due Hr 	Time, in hours, for next service due warning.	250Hrs	10-999 Hrs
Crank Cut Method 	Auto disconnects the crank command on detection of either voltage buildup/ voltage or oil pressure build up	Voltage Only	Voltage only Voltage or LLOP
Pick Up KVA warning KVA 	If the current level crosses this limit the contact is energized after the programmed supervision time	8	1-9999
Reset KVA warning KVA 	If the current level falls below this limit the contact is de-energized after the programmed supervision time.	8	1-9999
KVA Warning Delay KVA 	The supervision time for the above 2 parameters.	5	1-999Sec
Choke Pre time 	Keep the choke for this time before the engine has started.	Disable	Disable* 1-999 Sec
Choke Post time 	Keep the choke for this time after the engine has started.	Disable	Disable* 1-999 Sec
Pump Pre Time 	Activate the Pump by this time before cranking	2	1-999Sec
Engine Off Time E x	In manual mode, some time its required to switch off/on the engine at a predetermined time. This setting set the time for automatic switch off of the engine	Disable	00:01 to 23:59 Disable *

Engine On Time E✓	In manual mode, some time its required to switch off/on the engine at a predetermined time. This setting set the time for automatic switch ON of the engine	Disable	00:01 to 23:59 Disable*
-----------------------------	---	---------	----------------------------





• 12.3 Protection Parameter

Fuel Warn Level 	Monitoring value of fuel level below which fuel level warning is generated.	25 %	Disable* 11-80 %
Fuel Warn Delay 	Monitoring time of fuel level after which fuel level warning is generated.	10 Sec	1-999Sec
Fuel Trip Level 	Monitoring value of fuel level below which fuel level trip is generated.	15 %	10-80 %
Fuel Trip Delay 	Monitoring time of fuel level after which fuel level trip is generated.	10 Sec	1-999 Sec
LLOP Trip Level 	Monitoring value of lube oil pressure below which LLOP trip is generated.	1.0 Kg/cm ²	0.4-8.5 Kg/cm ²
LLOP Trip Delay 	Monitoring time of lube oil pressure after which LLOP trip is generated.	5 Sec	0-999 Sec
HWT Trip Level 	Monitoring value of water temperature below which HWT trip is generated.	90	40-250 Disabled*











<p>HWT Trip Delay</p> 	Monitoring time of water temperature after which HWT trip is generated.	5 Sec	1-999 Sec
<p>Oil Temp. Trip Level</p> 	Monitoring value of Oil temperature below which Oil Temp. trip is generated.	90	40-250 Disabled*
<p>Oil Temp. Trip Delay</p> 	Monitoring time of Oil temperature after which Oil Temp. trip is generated.	5 Sec	1-999 Sec
<p>D1-D7 Input Delay</p> 	Delay for 7 programmable digital inputs . Digital input are explained above.	5 sec	1-999 Sec
<p>Chg Alt-V Belt Delay</p> 	Duration for which the V-Belt signal should be continuously deactive to be recognized as a fault and action initiated. This fault is only enabled while the generator is running.	Disable	Disable 2-999 Sec
<p>Hooter ON Time</p> 	Duration for which the hooter shall be ON, if not externally reset, while announcing a fault.	30Sec	1-999 Sec
<p>Crank ON Time</p> 	Maximum crank time	5 Sec	1-999 Sec
<p>Crank Gap Time</p> 	The delay between two successive cranks	5 Sec	1-999 Sec
<p>Crank Attempts</p> 	The maximum number of cranks that shall be issued to start the Engine	3	1-10









Solenoid ON time 	The time for which stop solenoid will be kept active while stopping the engine	22 Sec	1-999Sec
Disp Auto Scroll 	Setting ON will enable Auto Scroll of display. OFF: No scroll and next parameter can be viewed by pressing next switch	ON	ON/OFF
Battery UV Warning 	Min. permissible battery voltage, below this the voltage is treated unhealthy & warning is generated.	Disabled	Disabled 9-35V
Battery OV Warning 	Max. permissible battery voltage, above this the voltage is treated unhealthy & warning is generated.	Disabled	9-35V Disabled







• 12.4 Comm RS485 Parameter

Device Id 	Modbus device ID	1	1-247
Baud Rate 	RS 485 Communication Baudrate	9600	1200 2400 4800 9600 19200
Parity 	RS 485 Communication Parity Bits	None	Even Odd None
Stop Bit 	RS 485 Communication Stop Bits	1	1 2

• **12.5 Annunciation (Available with output expander card)**

Ann. Mains OK 	Selected contact is activated if Mains Supply healthy.	Disabled	Disabled Contact on pin 1-12
Ann. Mains NOK 	Selected contact is activated if Mains Supply unhealthy.	Disabled	Disabled Contact on pin 1-12
Ann. Generator On 	Selected contact is activated if Generator is on.	Disabled	Disabled Contact on pin 1-12
Ann. Generator Off 	Selected contact is activated if Generator is off.	Disabled	Disabled Contact on pin 1-12
Ann. Fuel Trip 	Selected contact is activated if fuel fault registered	Disabled	Disabled Contact on pin 1-12
Ann. LLOP Trip 	Selected contact is activated if LLOP fault registered	Contact on pin 1	Disabled Contact on pin 1-12
Ann. HWT Trip 	Selected contact is activated if HWT fault registered.	Disabled	Disabled Contact on pin 1-12
Ann. Oil Temp Trip 	Selected contact is activated if Oil Temp fault registered.	Disabled	Disabled Contact on pin 1-12
Ann. Generator Voltage 	Selected contact is activated if Generator voltage is healthy.	Disabled	Disabled Contact on pin 1-12
Ann. Emergency 	Selected contact is activated if emergency fault is registered.	Disabled	Disabled Contact on pin 1-12

Ann. Generator Overload 	Selected contact is activated if generator is overloaded.	Contact on pin 5	Disabled Contact on pin 1-12
Ann. Generator Frequency 	Selected contact is activated if generator over frequency/under frequency fault registered	Disabled	Disabled Contact on pin 1-12
Ann. RWL Fault 	Selected contact is activated if RWL fault registered.	Disabled	Disabled Contact on pin 1-12
Ann. Charging alternator/V-belt 	Selected contact is activated if Charging alternator/V-belt fault registered.	Contact on pin 6	Disabled Contact on pin 1-12
Ann. Current Unbalance 	Selected contact is activated if Current Unbalance fault registered.	Disabled	Disabled Contact on pin 1-12
Ann. Fuel Open 	Selected contact is activated if fuel sensor is open.	Disabled	Disabled Contact on pin 1-12
Ann. LLOP Open 	Selected contact is activated if LLOP sensor is open.	Disabled	Disabled Contact on pin 1-12
Ann. HWT Open 	Selected contact is activated if HWT sensor is open.	Disabled	Disabled Contact on pin 1-12

Ann. Oil Temp. Open 	Selected contact is activated if Oil Temp. sensor is open.	Disabled	Disabled Contact on pin 1-12
Ann. Canopy Temperature 	Selected contact is activated if Canopy Temperature is high.	Disabled	Disabled Contact on pin 1-12
Ann. Oil level 	Selected contact is activated if Oil level is low.	Disabled	Disabled Contact on pin 1-12
Ann. Mains Overload 	Selected contact is activated if mains is overloaded	Disabled	Disabled Contact on pin 1-12
Ann. Service Due 	Selected contact is activated if Service is due.	Disabled	Disabled Contact on pin 1-12
Ann. Battery Voltage NOK 	Selected contact is activated if battery voltage is unhealthy	Disabled	Disabled Contact on pin 1-12

- **12.6 Reset Service Alarm**

	Press INC to Reset Press DEC to esc		
--	--	--	--

- **12.7 Adjust Clock**

	Automatic real time based DG Start & Stop (Manual Controller Configuration) RTC Time and Date can be easily entered	00.00	00.00 DD/MM/YYYY
--	---	-------	---------------------

- **12.8 Reset Password**

	Three digit password protection for system settings Password can be change easily.		
--	--	--	--

This parameter can be disabled while programming

These Parameters are model dependent

- **13.0 Analog Channel Data**

13.1 High Water Temperature Sensors Data :

Temp.	Resistance in ohms									
in °C	Type A	Type B	M&M	MNEPL	VE	Huafang	TATA	GC (VDO)	GC (Murphy)	TMTL Water
0	3282	1525	3282	3282	2363	2900	3192.6	3417	10613	3512
5	2765	1319	2765	2765	1873	2199	2461.1	2609	7764	2707
10	2247	1112	2247	2247	1383	1684	1914.6	2011	5743	2106
15	1730	906	1730	1730	1111	1301	1502.7	1564	4292	1653
20	1212	700	1212	1212	839	1015	1189.2	1227	3240	1308
25	1036	570	1036	1036	683	798	948.4	970	2469	1043
30	860	440	860	860	527	632	762.1	773	1898	838
35	684	365	684	684	434	505	616.7	621	1472	678
40	508	287	508	508	340	406	282.1	520	1050	552
45	426	260	426	426	283	327	502.5	438	885	453
50	343	232	343	343	226	247	412	356	720	374
55	291	205	291	291	190	214	340	288	560	310
60	238	178	238	238	154	187	282.1	220	410	259
65	203	151	203	203	131	154	235.5	183	360	217
70	167	123	167	167	107	120	197.6	145	300	183
75	144	96	144	144	92	101	166.6	128	240	155
80	120	69	120	120	76	85	141.2	110	193	132
85	104	62	104	104	66	74	120.2	95	160	113
90	88	54	88	88	55	62	102.8	80	145	97
95	77	46	77	77	48	55	88.3	71	120	83
100	66	38	66	66	41	47	76.2	61	100	72
105	58	35	58	58	36	41	66	52	90	63
110	50	31	50	50	30	36	57.4	45	80	55
115	45	27	45	45	27	31	43.8	40	70	48
120	39	23	39	39	23	27	33.9	34	55	42
125	34	19	34	34	21	24	30	30	45	37
130	30	15	30	30	18	21	26.6	27	38	33
135	27	11	27	27	16	18	23.7	23	33	29
140	25	0	25	25	14	15	21.1	21	29	26
145	23	0	23	23	12	12	18.9	18	25	23
150	21	0	21	21	10	10		16	22	20

13.1 High Water Temperature Sensors Data :

S.No	Temperature in °C	Resistance in ohms	
		TMTL AIR3C	TMTL AIR1C
1	80	300	300
2	85	279.3	273.1
3	90	258.5	246.2
4	95	237.8	223.8
5	100	217	208.5
6	105	201.3	193.1
7	110	185.5	177.7
8	115	169.8	162.3
9	120	154	146.9
10	125	138.3	131.5
11	130	122.5	116.2
12	135	106.8	100.8
13	140	91	85.4
14	145	76.3	70
15	150	61.5	57.3
16	155	46.8	44.7
17	160	32	32
18	165	30.3	30.3
19	170	28.5	28.7
20	175	26.8	27
21	180	25	23.6
22	185	22.3	20.2
23	190	19.5	16.8
24	195	16.8	13.4
25	200	14	10
26	205	13	
27	210	12	
28	215	11	
29	220	10	

13.2 Low Fuel Sensors Data :

S.No.	Fuel in %	Resistance in ohms				
		Type A	Sam_0	Sam_1	Electronics	Linear
1	0	0	14	10	10	10
2	5	5	18	18.5	19.5	18.5
3	10	10	22	27	29	27
4	17	17	29.5	35.5	38.5	35.5
5	20	34	37	44	48	44
6	25	51	55.5	52.5	57.5	52.5
7	30	68	74	61	67	61
8	35	85	92	69.5	76.5	69.5
9	40	102	110	78	86	78
10	45	110.5	124.5	86.5	95.5	86.5
11	50	119	139	95	105	95
12	55	127.5	149	103.5	114.5	103.5
13	60	136	159	112	124	112
14	65	144.5	165	120.5	133.5	120.5
15	70	153	171	129	143	129
16	75	157.7	172.5	137.5	152.5	137.5
17	80	162.3	174	146	162	146.5
18	85	167	176	154.5	171.5	149.5
19	90	171.7	178	163	181	153
20	95	176.3	181	171.5	190.5	166.5
21	100	180	184	180	200	180

13.3 Low Lube Oil Pressure Sensors Data (Resistive Type):

Pressure	Resistance In Ohms									
In Kg/cm ²	Type A	Type B	M&M	MNEPL	Volvo	TMTL	Huafang	TATA	GC (VDO)	GC (Murphy)
0	10	10	10	10	15	10	10	10	10	240
0.5	16.5	20	16.5	20.5	19.5	21	20	20.5	20	214
1	23.5	30	23.5	31	24	32	30	31	30	189
1.5	30.2	40	30.2	41.5	28.5	43	40	41.5	41	166
2	37	50	37	52	33	54	50	52	52	147
2.5	49.5	58.7	49.5	70	40.5	62.7	58.7	61	61	129
3	62	67.5	62	88	48	71.5	67.5	70	70	115
3.5	74.5	76.2	74.5	106	54.5	80.2	76.2	79	79	102
4	87	86	87	124	61	89	85	88	88	91
4.5	96	93.5	96	142	63.5	97.7	93.5	97	97	81
5	105	102	105	160	66	106.5	102	106	106	71
5.5	114	110	114	178	72.5	115.2	110.5	115	115	61
6	123	119	123	196	79	124	119	124	124	51
6.5	133.5	127.2	133.5	214	82	132.7	127.2	132	132	41
7	143	135.5	143	232	85	141.5	135.5	140	139	31
7.5	152.5	143.7	152.5	250	87.5	150.2	143.7	148	146	24
8	162	152	162	268	90	159	152	156	152	20
8.5	171.5	159	171.5	286	95	167.7	159	164	159	16

13.4 Low Lube Oil Pressure Sensors Data (4-20mA Type):

S.No	Current (mA)	Pressure (Kg/cm ²)
1	4.0	0.0
2	5.6	1.0
3	7.2	2.0
4	8.8	3.0
5	10.4	4.0
6	12.0	5.0
7	13.6	6.0
8	15.2	7.0
9	16.8	8.0
10	18.4	9.0
11	20.0	10.0

• 14.0 Relay Expander Module

The relay expander module provide a potential free contact for annunciations. These annunciations can be enabled in the ECON (see "Annunciations Parameter")

Relay expander module also offering a general purpose interface RS-485. The RS-485 parameter can be changed in the econ (see "Comm RS-485")

The ECON controller communicate with expander module through RS-232 communication.

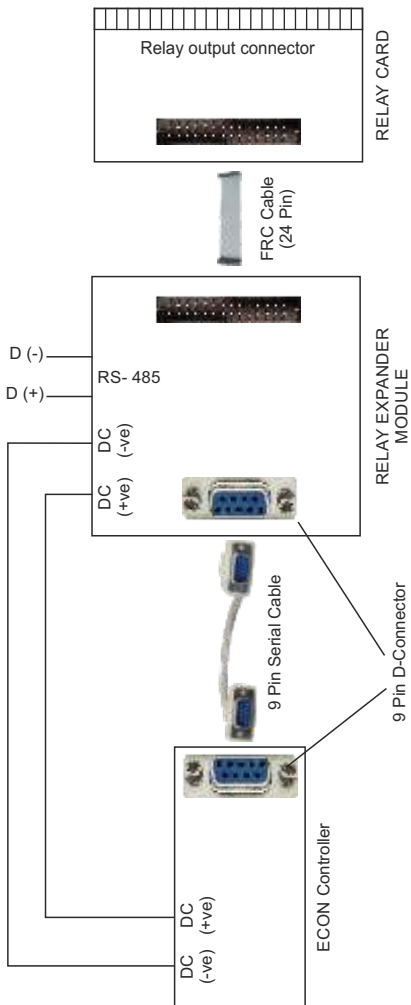

Block Diagram

• 15.0 Model Selection Chart

MODEL OF ECON CONTROLLER	Analog Channel		Availability of RS-485	
	3	4	Yes	No
ECON-M-321	■			■
ECON-M-322	■		■	
ECON-M-421		■		■
ECON-M-422		■	■	

Note: Extra Channel is Oil Temperature Sensor

• 16.0 Load Management

ECON-A has programmable contact Load management function. The load management contact will switch on when the current on the generator has crossed a programmed limit and will reset when the current has fallen below the reset programmed limit. This function can be used to cut-off unnecessary loads or start a second generator when the load goes above a limit.

• 17.0 Event Recording:

ECON keeps a log of last 64 events. Setting change and warning are considered as event. Events are stamped along with date and time

• 18.0 Faults

ECON keeps a log of last 64 Faults. These Faults are stamped along with date and time There are two categories of faults

- Internal Faults
- External faults

• 18.1 Internal Faults

Internal faults are the faults, which do not need any external signals and are detected by the system itself. They are:

- Generator Voltage Unhealthy
- Generator Frequency Unhealthy.
- Generator over Speed.
- Over Load

• 18.2 External Faults

Those faults which cannot be sensed by the unit itself (these faults are not reflected by the generator voltage) and are to be provided externally. They are:

- LLOP
- RWL
- Emergency
- HWT
- Fuel
- Canopy Temp
- Oil Level
- Oil Temp.
- Earth Fault

• 18.3 Fault Reset

Internal Faults & LLOP fault:

All internal faults and LLOP fault can be reset by pressing (R) switch after the generator is stopped. External Fault except LLOP & V-Belt faults:

These faults cannot be reset till the engine is running and/or fault conditions persist. Once the faults are rectified, the fault can be reset by pressing Reset switch (R). In case the engine fails to stop "STOP KEY" can be pressed for manual attempt to stop engine

• 19.0 Communication

- Rs232
- USB
- Modbus on Isolated Rs485 (optional)

• 20.0 Technical Specifications

AC voltage withstand	330 VAC (Phase to neutral)
Measurement Accuracy	
Voltages & Current	1% of Reading
Power & Energies	2% of Reading
Surge 1.2/50Usec	2.5KV
Battery Voltage	9-35 V DC
DC Interruption time	0.4 Sec
Cut out Dimensions	155mm X 117mm
Depth	41.8 mm
Digital Input Level	Battery Voltage (Negative)
Digital Output	Battery Voltage (Negative)

• 21.0 Terminal Numbers

Terminal No.	Description
1	Fan Current S1
2	Fan Current S2
3	NC
4	CT Common
5	CT B
6	CT Y
7	CT R
8	Sensor Oil Temp.
9	Sensor LLOP
10	Sensor HWT
11	Sensor Fuel
12	V-DG-N
13	V-DG-B
14	V-DG-Y
15	V-DG-R
16	NC
17	NC
18	NC
19	NC
20	NC
21	NC
22	NC
23	D Input 4
24	D Input 3
25	D Input 2
26	D Input 1
27	Emergency
28	R Stop
29	R Start
30	Programmable Output 3

31	Programmable Output 2
32	Programmable Output 1
33	Hooter
34	Solenoid
35	Crank
36	NC
37	NC
38	Chg. Alt. Contact
39	Battery(+ve)(8-35 V DC)
40	Battery(-ve)
41	Sensor(-ve)
42	D Input 5
43	D Input 6
44	D Input 7
45	D(+): RS485
46	D(-):RS485

Connect the wires as per the labelling done in back sticker:

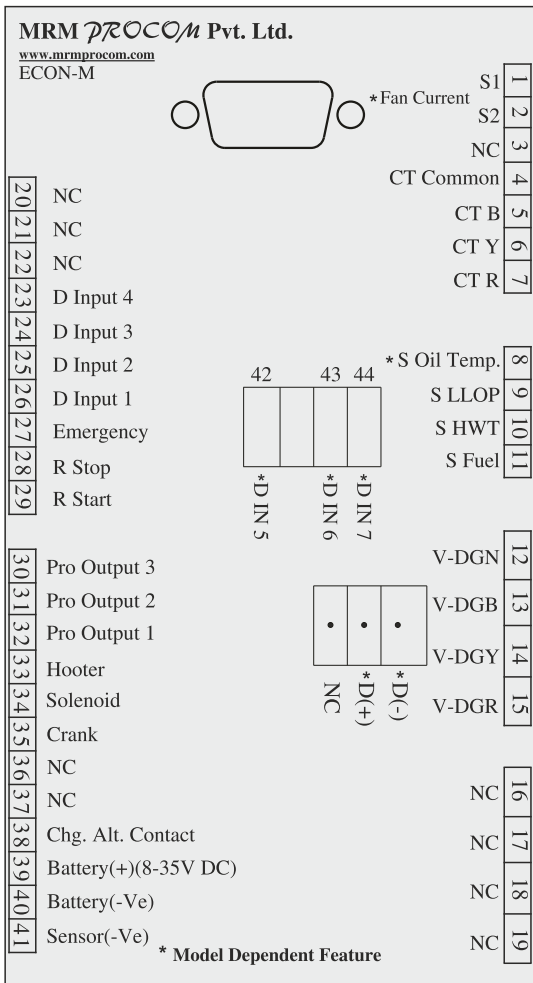

• 22.0 Dimensions

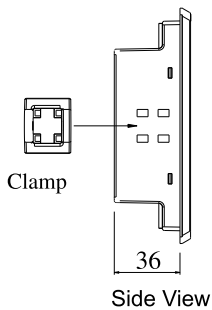
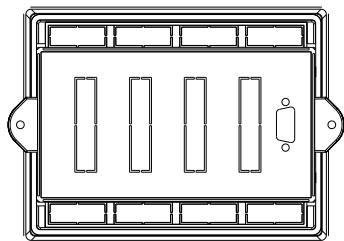
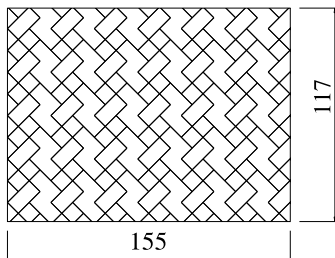
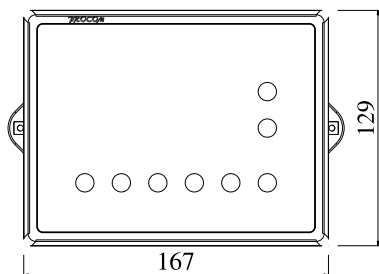

MRM *PROCOM*[®] Pvt. Ltd.
Plot No. 20-21, Industrial Estate
Sector-59 (II), HUDA, Faridabad-121004, Haryana
Phone: 0129-4700400 (10 Lines), E-mail : info@mrmprocom.com
Website : www.mrmprocom.com